

15 ml  
50 ml  
125 ml

FEA 13 or 15

49 gr  
128 gr  
227 gr

73,3 mm  
109,5 mm  
138,7 mm

29,3 mm  
40 mm  
51,4 mm



*n.1*  
Eau de Toilette

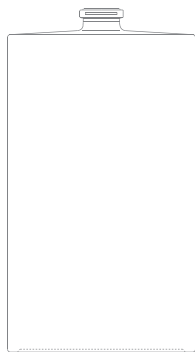

  
30 ml  
50 ml  
100 ml

  
FEA 15

  
94 gr  
135 gr  
201 gr

  
70,4 mm  
102,1 mm  
120,9 mm

  
27x55 mm  
27x55 mm  
32,6x66,2 mm



*n.2*  
Eau de Toilette

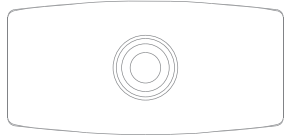
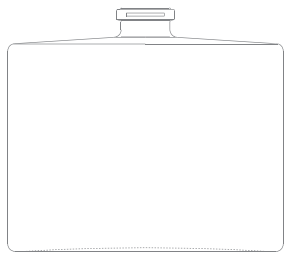

  
30 ml  
50 ml  
100 ml

  
FEA 15

  
126 gr  
187 gr  
344 gr

|  
56,3 mm  
63,9 mm  
76,5 mm

L  
31,2x62,6 mm  
35,7x72,3 mm  
45x88,5 mm



*n.3*  
Eau de Toilette

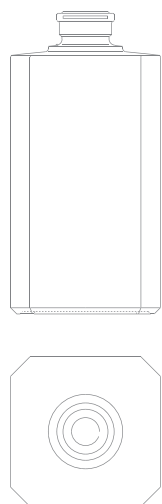

30 ml  
50 ml  
100 ml

FEA 18 or 20

98 gr  
143 gr  
216 gr

66,2 mm  
79 mm  
97,5 mm

36,5x36,5 mm  
41,5x41,5 mm  
48,3x48,3 mm



*n.5*  
Eau de Toilette



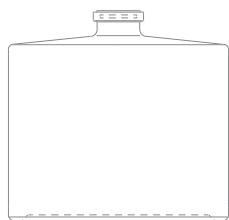

  
30 ml  
60 ml  
100 ml

  
FEA 15

  
70 gr  
136 gr  
190 gr

  
49,7 mm  
50,2 mm  
63,2 mm

  
51 mm  
63 mm  
66 mm



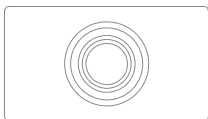
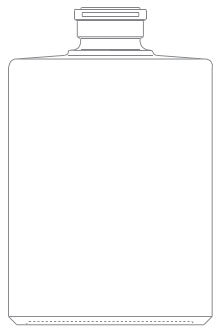

*n.6*  
Eau de Toilette



  
 15 ml  
 30 ml  
 50 ml  
 60 ml  
 100 ml  
 125 ml

  
 FEA 13 or 15  
 FEA 18 or 20  
 E4 or E5 or 18/415

  
 48 gr  
 83 gr  
 119 gr  
 154 gr  
 208 gr  
 255 gr

  
 55,7 mm  
 68,5 mm  
 78,3 mm  
 83 mm  
 93,8 mm  
 100,9 mm

  
 20,6x38 mm  
 25,3x46,1 mm  
 28,8x51,3 mm  
 31,6x55,5 mm  
 35,8x63,3 mm  
 39x68 mm



*n.7*  
Eau de Toilette



  
30 ml  
50 ml  
100 ml

  
FEA 15  
E4 or E5

  
82 gr  
100 gr  
175 gr

  
88,15 mm  
102,7 mm  
115,7 mm

  
33x45 mm  
36,7x50,2 mm  
45,4x62,1 mm



*n.8*  
Eau de Toilette



10 ml



FEA 13  
E4



35 gr



85,1 mm



20,5 mm



*n.12*  
Eau de Toilette

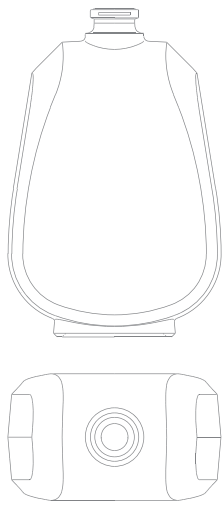

30 ml  
50 ml  
100 ml

FEA 15 or 18  
E4 or E5

85 gr  
95 gr  
155 gr

76.5 mm  
92.3 mm  
110 mm

30.6x48.5 mm  
30x52.2 mm  
37.5x65 mm



*n.13*  
Eau de Toilette

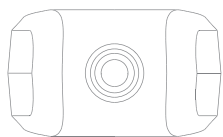
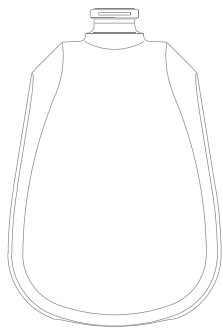

  
30 ml  
50 ml  
100 ml

  
FEA 15

  
75 gr  
105 gr  
192 gr

  
67,9 mm  
77,2 mm  
93,6 mm

  
26,2x50,7 mm  
30,3x58,6 mm  
37,5x72,5 mm



*n.13b*  
Eau de Toilette

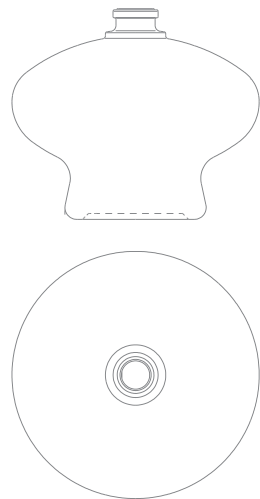

50 ml  
100 ml

FEA 15  
E4

122 gr  
225 gr

59,6 mm  
71,6 mm

68,8 mm  
84 mm



*n.14*  
Eau de Toilette

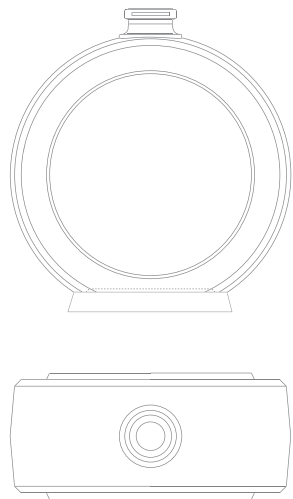

  
30 ml  
50 ml  
100 ml

  
FEA 15 or 18  
E4 or E5

  
78 gr  
78 gr  
165 gr

  
73,7 mm  
76,8 mm  
104,8 mm

  
27,4x56,9 mm  
26,2x66 mm  
32x84 mm



*n.16*  
Eau de Toilette



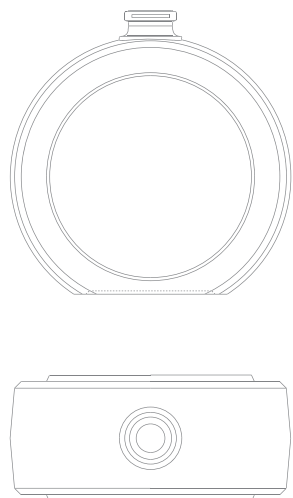

30 ml  
50 ml  
100 ml

FEA 15

78 gr  
110 gr  
183 gr

61,7 mm  
70,1 mm  
85,7 mm

26,7x59,3 mm  
30,8x68,2 mm  
37,5x83,1 mm



*n.16b*  
Eau de Toilette

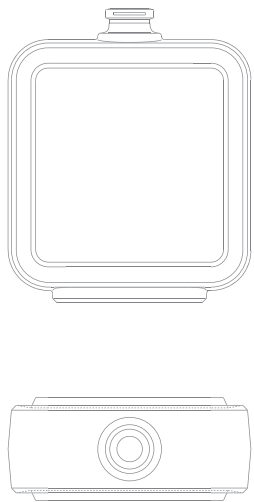

  
30 ml  
50 ml  
100 ml

  
FEA 15 or 18  
E4 or E5

  
87 gr  
95 gr  
170 gr

  
70,4 mm  
84,6 mm  
100 mm

  
25,4x50,5 mm  
25,4x60,2 mm  
32,3x74,2 mm



*n.17*  
Eau de Toilette

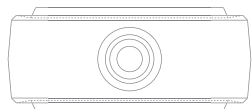
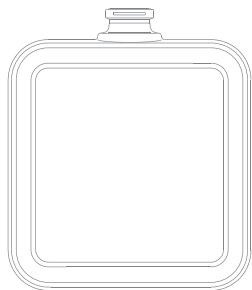

  
30 ml  
50 ml  
100 ml

  
FEA 15

  
73 gr  
98 gr  
177 gr

  
60,7 mm  
68 mm  
82,6 mm

  
25,4x51,9 mm  
28,9x59 mm  
35,9x73,3 mm



*n.17b*  
Eau de Toilette

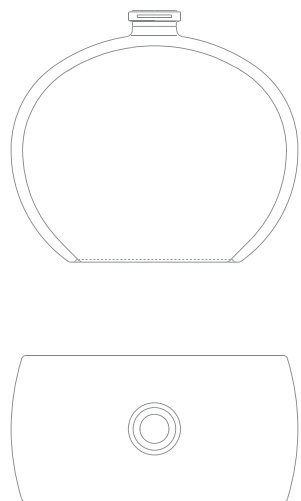

50 ml  
100 ml



FEA 15



132 gr  
210 gr



62 mm  
73,9 mm



35,5x69,4 mm  
43x84 mm



*n.20*  
Eau de Toilette

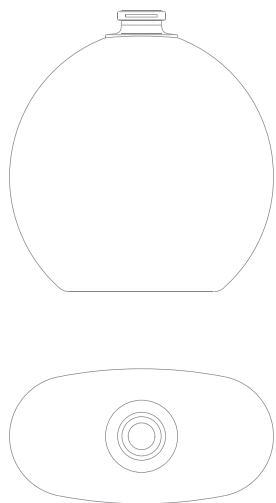

50 ml  
100 ml



FEA 15



129 gr  
204 gr



74,8 mm  
89,8 mm



35,5x69,4 mm  
43x84 mm



*n.21*  
Eau de Toilette

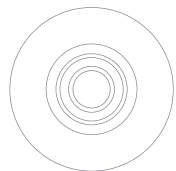
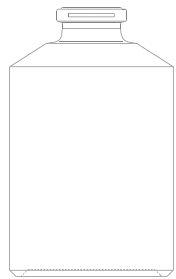

  
30 ml  
50 ml  
100 ml

  
E4  
FEA 15

  
70 gr  
120 gr

|  
73,6 mm  
87,5 mm

∅  
42,5 mm  
51 mm



*n.30*  
Eau de Toilette

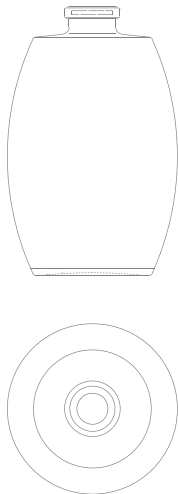

  
30 ml  
50 ml  
100 ml

  
FEA 15

  
60 gr  
90 gr  
170 gr

  
64,7 mm  
74 mm  
90,5 mm

  
39,9 mm  
46,9 mm  
58 mm



*n.33*  
Eau de Toilette

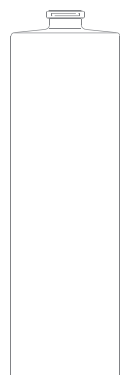

15 ml  
50 ml  
100 ml



FEA 13 or 15



50 gr  
140 gr  
240 gr



87,3 mm  
122,5 mm  
148,1 mm



19,2x24,8 mm  
27,6x35,7 mm  
43,8x33,8 mm



*n.44*  
Eau de Toilette



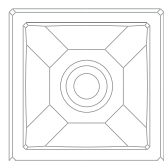
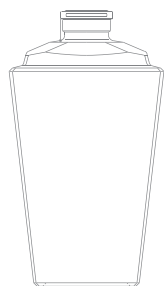

30 ml  
50 ml  
100 ml



FEA 15  
E4



80 gr  
95 gr  
180 gr



69,6 mm  
79,9 mm  
97,5 mm



39,3 mm  
43,9 mm  
54,7 mm



*n.50*  
Eau de Toilette

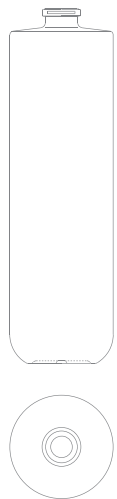

  
50 ml  
100 ml

  
FEA 15  
E4

  
75 gr  
150 gr

  
112,4 mm  
139,8 mm

  
32,4 mm  
40,7 mm



*n.51*  
Eau de Toilette

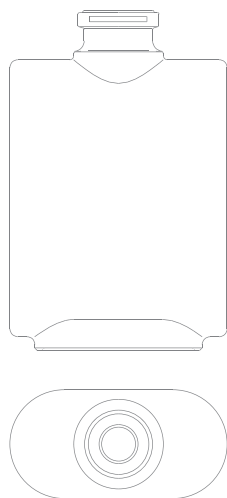

50 ml  
100 ml



FEA 18  
E5



90 gr  
183 gr



85,9 mm  
105,9 mm



27,3x54,5 mm  
34,2x69,5 mm



*n.92*  
Eau de Toilette

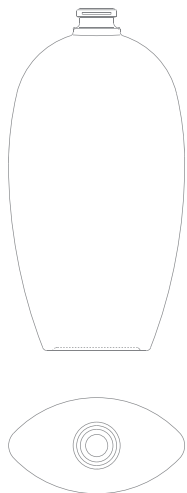

50 ml  
100 ml



E4  
FEA 15



100 gr  
180 gr



104,7 mm  
136,6 mm



29,9x54,4 mm  
36,8x67,4 mm



*n.97*  
Eau de Toilette

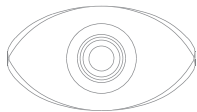
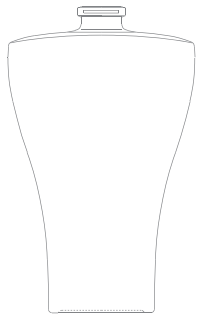

50 ml  
100 ml

FEA 15  
E4

111 gr  
200 gr

96,4 mm  
117,6 mm

33x58,8 mm  
40,8x72,6 mm



*n.98*  
Eau de Toilette

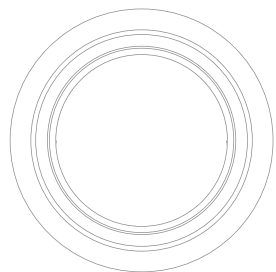
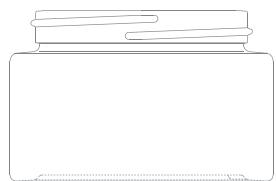

50 ml



GPI 400-58



170 gr



43,2 mm



66,6 mm



*n.40*

*Semi-automatic  
manufacturing*



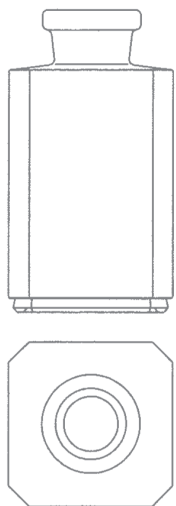

8 ml  
15 ml  
30 ml

8,5 mm  
10 mm  
12,5 mm

29 gr  
57 gr  
94 gr

44 mm  
55,3 mm  
67,1 mm

24,5 mm  
30 mm  
36,5 mm



*n.5*  
Perfume



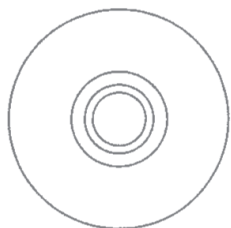
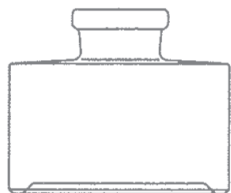

  
8 ml  
15 ml  
30 ml

  
8,5 mm  
10 mm  
12,5 mm

  
25 gr  
41,5 gr  
74 gr

  
29,5 mm  
35 mm  
43 mm

  
33,8 mm  
41,5 mm  
51 mm



*n.6*  
Perfume

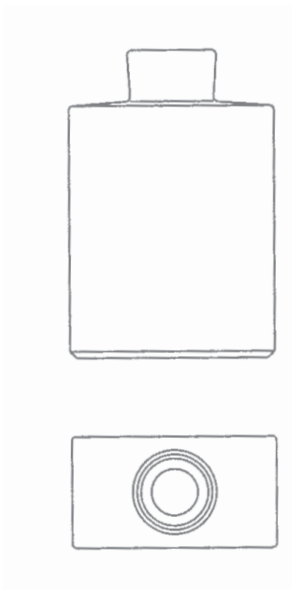

-   
8 ml  
15 ml  
30 ml
  -   
8,5 mm  
10 mm  
12,5 mm
  -   
27 gr  
49 gr  
85 gr
  -   
46,5 mm  
57 mm  
70,5 mm
  -   
16,8x30,1 mm  
20,6x38 mm  
25,3x46,1 mm
- 



*n.7*  
Perfume

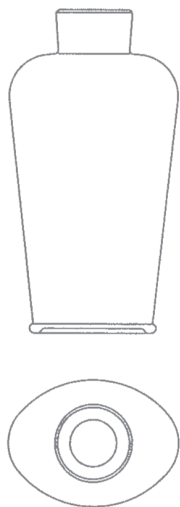

8 ml  
15 ml  
30 ml

8,5 mm  
10 mm  
12,5 mm

28 gr  
46 gr  
85 gr

59,5 mm  
70 mm  
88 mm

22x30 mm  
27x36,6 mm  
33x45 mm



*n.8*  
Perfume

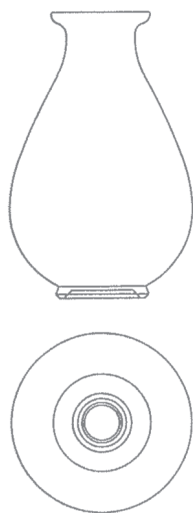

  
8 ml  
15 ml  
30 ml

  
8,5 mm  
10 mm  
12,5 mm

  
26,5 gr  
50 gr  
80 gr

  
47,8 mm  
59,7 mm  
72,2 mm

  
30,4 mm  
37,9 mm  
46 mm



*n.9*  
Perfume

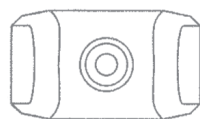
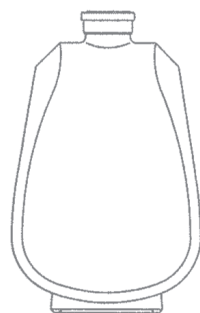

8 ml  
15 ml  
30 ml

8,5 mm  
10 mm  
12,5 mm

25 gr  
47,5 gr  
85 gr

48,7 mm  
59,7 mm  
72,7 mm

19,8x31,4 mm  
24,8x39,3 mm  
30,6x48,5 mm



*n.13*  
Perfume

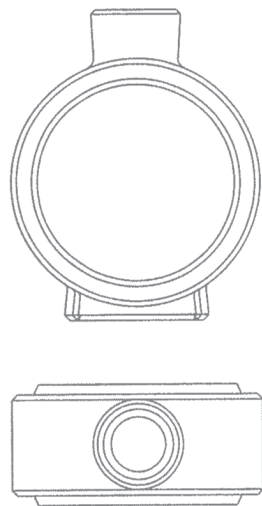

8 ml  
15 ml  
30 ml

8,5 mm  
10 mm  
12,5 mm

27,5 gr  
47 gr  
86 gr

47,7 mm  
57,2 mm  
69,6 mm

18,1x37,2 mm  
22,1x45,7 mm  
27,4x56,9 mm



*n.16*  
Perfume

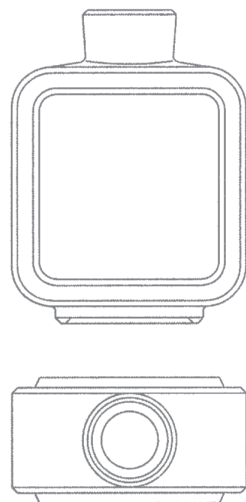

  
8 ml  
15 ml  
30 ml

  
8,5 mm  
10 mm  
12,5 mm

  
27,5 gr  
48 gr  
87 gr

  
46,1 mm  
55 mm  
69,1 mm

  
18,1x33,5 mm  
22,1x41 mm  
27,4x50,5 mm



*n.17*  
Perfume

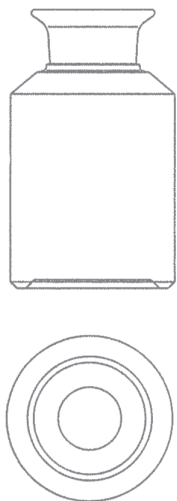

15 ml  
30 ml

10 mm  
12,5 mm

30 gr  
60 gr

52,2 mm  
66,7 mm

31,5 mm  
38 mm



*n.30*  
Perfume



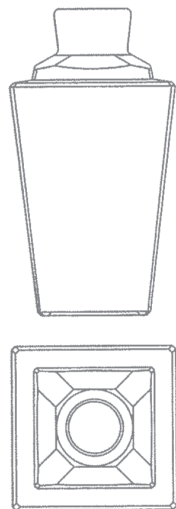

8 ml  
15 ml  
30 ml

8,5 mm  
10 mm  
12,5 mm

27,5 gr  
47 gr  
80 gr

49 mm  
59,5 mm  
71,8 mm

26,4 mm  
32,1 mm  
39,3 mm



*n.50*  
Perfume

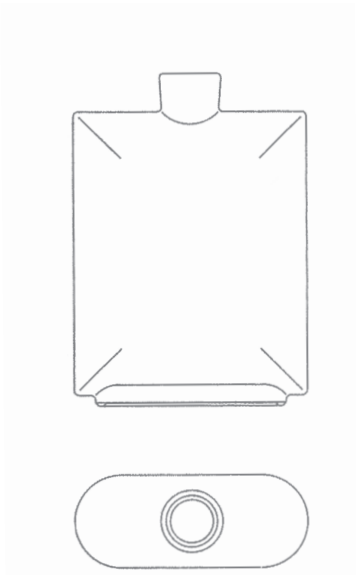

  
8 ml  
15 ml

  
8,5 mm  
10 mm

  
35 gr  
69 gr

  
45,1 mm  
54,5 mm

  
17,7x44,2 mm  
22x55 mm



*n.92*  
*Perfume*

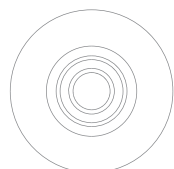
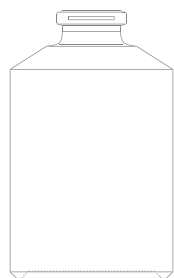

- 5 ml
- 15 ml
- 30 ml
- 60 ml
- 125 ml
- 250 ml
- 500 ml
- 1000 ml

- PH 18/E 18
- E18
- E22
- PE7

- 17 gr
- 30 gr
- 60 gr
- 86 gr
- 135 gr
- 255 gr
- 420 gr
- 750 gr

- 42 mm
- 52,2 mm
- 66,7 mm
- 80,7 mm
- 107,9 mm
- 130,9 mm
- 166,4 mm
- 206,9 mm

- 23,5 mm
- 31,5 mm
- 38 mm
- 45,2 mm
- 54 mm
- 66,6 mm
- 82 mm
- 100 mm



*n.30*  
Essential oils



*n° 205*



*n° 206*



*n° 216*



*n° 219*



*n° 207*



*n° 208*



*n° 223*



*n° 225*



*n° 211*



*n° 212*



*n° 257*

*Stoppers*